

# The influence of stirrer size and chamber load on the number of uncorrelated samples created in a reverberation chamber

Magnus Otterskog, Ph.D.-student  
Department of technology  
Örebro University  
Sweden  
[magnus.otterskog@tech.oru.se](mailto:magnus.otterskog@tech.oru.se)

**Abstract**-A  $2^3$  factor experiment is carried out in order to examine the effect on the number of uncorrelated samples (NUS) that is created in a reverberation chamber. The three factors that are examined are stirrer diameter, stirrer position and chamber Q-value. The most interesting factors, chamber Q-value and stirrer diameter, are then examined in a  $3^2$  factor experiment and presented with simple regression models.

## I. Introduction

When using a reverberation chamber for measurements of many kinds an interesting parameter is the number of uncorrelated samples NUS. The NUS gives the uncertainty that you can obtain in your measurements and it is a result of the statistical properties that you use when working with a reverberation chamber. The NUS is commonly supposed to be related to the number of different mode structures that you can obtain with the mode stirring device of your chamber. In order to obtain this different mode structures one have showed that the stirrer should be electrically large [1] in order to give enough frequency shift for the eigenmodes created by the cavity structure. A large frequency shift of the eigenmodes will enable modes to be shifted in and out of the bandwidth of the cavity and thus excite a new set of modes for each new stirrer position (cavity structure). This will add randomness to the mode stirring of the chamber. Lots of work have been made [2] [3] to find stirrer configurations that will give the best possible statistical field uniformity in the chamber and it has also been showed [2] [4] that use of several stirrers will increase the stirring efficiency. The number of simultaneously excited modes in the chamber is highly related to the chamber Q. An expression for the number of simultaneously excited modes is given in for instance [5] as:

$$N_s = \frac{8\pi \cdot V \cdot f^3}{c^3 \cdot Q} \quad (1)$$

Here one can see that the number increases with a smaller Q-value of the chamber, which is natural since a smaller Q gives a larger bandwidth of the chamber and therefore a larger number of excited modes. This paper examines if it is possible to build a stirrer efficient enough to take advantage of this larger number of simultaneously excited modes and by stirring, shift more eigenmodes in and out of the chamber bandwidth and increase randomness.

## II. The equipment

A small reverberation chamber of size  $1 \times 0.5 \times 0.5$  m is used and the frequency used is 2.5 GHz. For every test run 801 samples of the relative transmission coefficient, between two small WLAN antennas, are registered with a Network analyzer. The stirrer is driven by a DC-motor and set to rotate (almost) one full turn per test sequence. The stirrers used in the experiments are shown in figure 1 and are, except for the largest one, of zig-zag type. All stirrers are of the same height but they differ in diameter. The chamber Q is controlled with flat absorbers in different sizes that are placed inside the chamber. Finally the stirrer's position can be altered between a central position in the chamber and a position close to a corner.

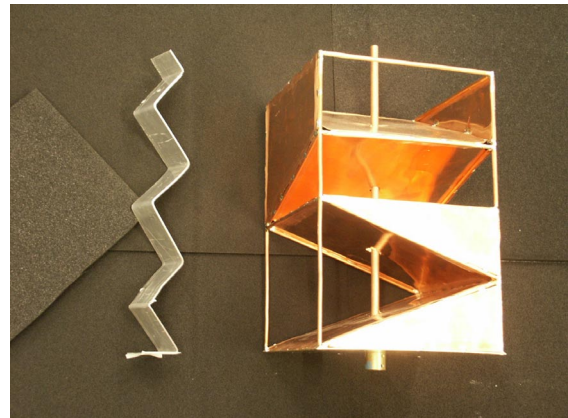

Figure 1a. The stirrers used in the  $2^3$  experiment.



Figure 1b. The stirrers used in the  $3^2$  experiment.

### III. The 2<sup>3</sup> factor experiment

The full factor experiment [6] examined the response variable, NUS, for two levels of the three different factors, stirrer diameter (SD), stirrer position (SP) and chamber Q (CQ). The response variable matrix is therefore a three dimensional matrix with two levels in each dimension which gives a total of 2<sup>3</sup>=8 elements. A minus sign for the factors SD, SP and CQ represent, a small stirrer, stirrer placed in the corner position and a loaded chamber (low Q) respectively. Plus signs represent a large stirrer, stirrer placed in the central position and an unloaded chamber (high Q) respectively. The NUS is obtained by looking at the auto correlation function and searching for the sample shift (offset) that gives a correlation less than  $e^{-1}$ . The total number of samples is then divided by the offset and this gives the NUS.

$$NUS = \frac{\text{total number of samples}}{\text{offset (correlation less than } e^{-1})} \quad (2)$$

Actually, since the interesting parameter is the number of statistically independent samples. And that uncorrelated not always imply statistical independence there are better methods for finding the true number of independent samples see for instance [2] but as long as the total number of samples is the same in all test cases the method is fast and accurate enough. A factor experiment is used for finding factors that significantly affects the response variable. This is called the main effect of the factor and beside this the experiment is also able to detect interaction effects between factors. The response variable matrix looks as shown in figure 2.

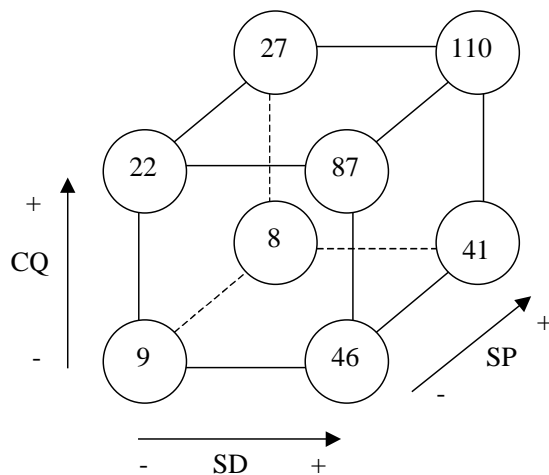

Figure 2. The response variable matrix for the 2<sup>3</sup> experiment. The NUS for every factor combination is given in the circles.

Every value for the different factor combinations is a mean value of three replicated runs with different positions of the transmitting antenna. This means

that an estimated variance can be calculated for every factor combination and this will help us draw a useful conclusion later. As we can see a large stirrer diameter and a high chamber Q gives many uncorrelated samples. Calculating the effects from this experiment will give a result shown in Table 1. The effects are presented with the  $\pm 1$  standard deviation limits.

factor	est. effect	$\pm 1$ std
SD (stirrer diameter)	54.5	4.15
SP (stirrer position)	5.5	4.15
CQ (chamber Q)	35.5	4.15
SD*SP	3.5	4.15
SD*CQ	19.5	4.15
SP*CQ	8.5	4.15
SD*SP*CQ	5.5	4.15

Table 1. Main effects and interaction effects on the response variable NUS.

This experiment clearly shows an effect on the NUS for the factors SD (stirrer diameter) and CQ (chamber Q). The experiment also shows an interaction effect between the SD and CQ factors. We also examine the residuals for all the experimental runs and find that the variance seems to increase with an increasing number of independent samples, see figure 3. The residuals are the deviation from the mean value within the three replicated runs for every factor combination. The residuals are supposed to be normal distributed.

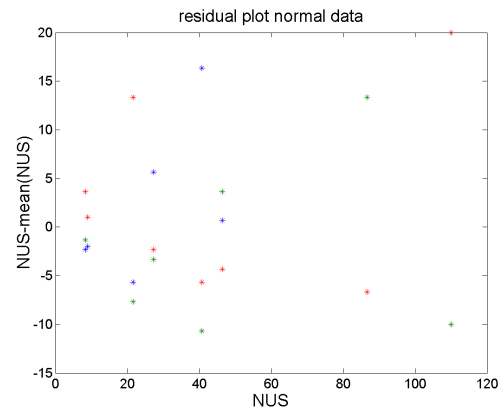

Figure 3. The residual plot of the 3\*8=24 experimental runs.

The increase of variance as the response variable (NUS) gets larger is a problem. The large interval of the response variable can create non-physical interaction effects [6]. In order to get rid of this [6] and [7] suggests a transformation of the data. In my case the logarithmic function was used to transform the data and this gives a new table of the effects according to table 2.

factor	est. effect	$\pm 1$ std
SD (stirrer diameter)	0.66	0.20
SP (stirrer position)	0.029	0.20
CQ (chamber Q)	0.40	0.20
SD*SP	-0.014	0.20
SD*CQ	-0.041	0.20
SP*CQ	0.089	0.20
SD*SP*CQ	-0.0017	0.20

Table 2. Main effects and interaction effects for the logarithm of the response variable.

As we look at the plotted residuals for the logarithmic response variable in figure 4 we see that the variance is more equal and that the normality criterion seems to be better fulfilled. After the transformation the experiment indicates that only the factors SD (stirrer diameter) and CQ (chamber Q) have a significant effect on the number of uncorrelated samples obtained from a chamber. No interaction effects are significant. To further investigate the effect of factors SD and CQ we expand the experiment with a third level of the factors but this time we only examine the two significant factors SD and CQ giving a  $3^2$  factor experiment.

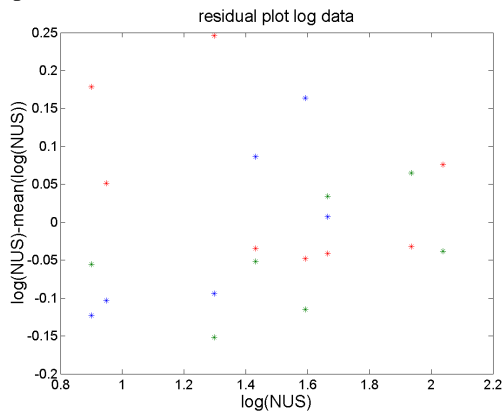

Figure 4. The residual plot of the logarithmic response variable.

#### IV. The $3^2$ experiment

A third level of the factors SD and CQ are introduced and this will give an experiment with a total of 9 factor combinations. The response variable matrix looks like in figure 5. As before the range of the response variable is too high so it needs to be transformed with the logarithmic function in order to create a uniform variance within the experiment. Since we already know that the factors SD and CQ significantly affect the NUS, this experiment is made to find out **how** they affect the NUS. Figures 6 and 7 show the NUS as a function of the stirrer's diameter and stirred volume respectively. The figures also include regression lines found by the least square error method. Both figures show that no interaction effect

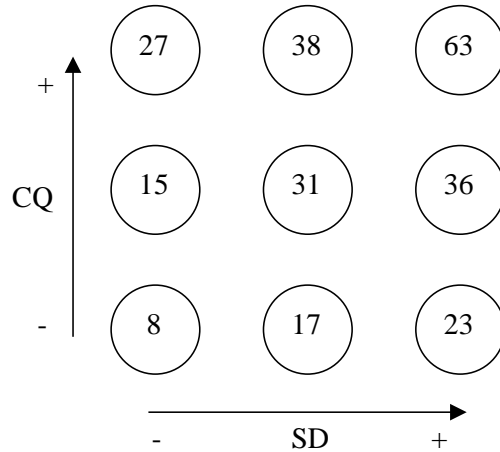

Figure 5. The response variable matrix for the  $3^2$  experiment. The NUS for every factor combination is given in the circles.

between the factors is present and this makes sense according to the results from the  $2^3$  experiment. According to the regression lines, the NUS seems to increase proportional to an increase of the diameter of the stirrer rather than to an increase of the volume of the stirrer. For every load case, a fourth point is added to the data before the regression lines are calculated. This extra point corresponds to a stirrer size of 0 that is supposed to give only 1 uncorrelated sample.

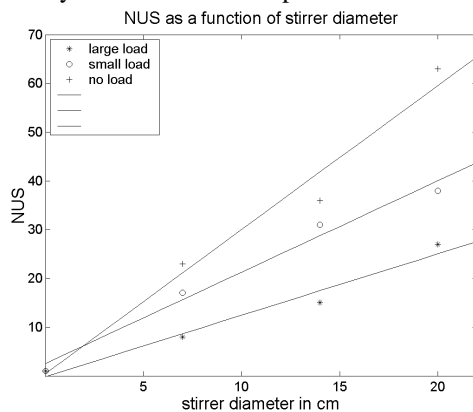

Figure 6. The NUS as a function of stirrer diameter.

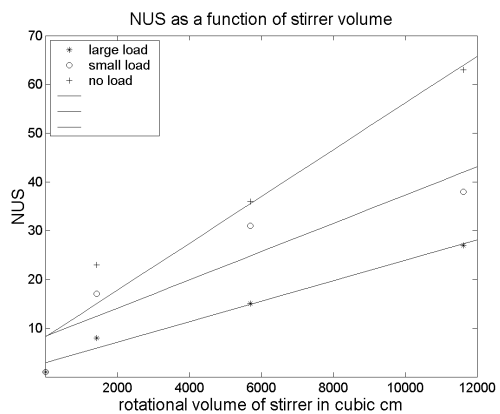

Figure 7. The NUS as a function of stirrer volume.

## V. Conclusions

We have found that the NUS is significantly affected by the stirrer's diameter and the chamber's Q-value. A high Q-value and a large stirrer diameter give many uncorrelated samples. We have also found that the stirrer's position does not, significantly, affect the NUS obtained in a chamber. Also, by looking at simple, linear regression lines we conclude that the NUS increase proportional to an increase of the stirrer diameter rather than to an increase of stirrer volume.

## VI. Discussion

The initial idea was that an efficient stirrer could take advantage of the low cavity Q and the large number of existing eigenmodes within the bandwidth of the cavity for a loaded chamber and maybe create a larger NUS than for an unloaded chamber. The efficient stirrer was to create a large amount of eigenfrequency shift and thereby enable a larger number of eigenmodes to be shifted in and out of the bandwidth of the cavity and add more randomness to the stirring. This idea must be rejected since nothing in the experiment shows any sign of this idea being true. A large number of simultaneously excited modes is thus not something to strive for since it tends to decrease the NUS that can be obtained from the stirrer.

## Acknowledgement

I would like to thank Mats Bäckström and Olof Lundén at the Swedish Defence Research Agency, Kent Madsén at Flextronics Design and Paul Hallbjörner at Ericsson AB for their useful ideas and comments.

## References

- [1] D. I. Wu and D. C. Chang, "The effect of an Electrically Large Stirrer in a Mode-Stirred Chamber" in *IEEE Transactions on electromagnetic compatibility*, vol. 31, No. 2, May 1989.
- [2] O. Lundén and M. Bäckström, "Stirrer Efficiency in FOA Reverberation Chambers. Evaluation of Correlation Coefficients and Chi-Squared Tests" in *Proceedings of 2000 IEEE International Symposium on Electromagnetic Compatibility, Washington DC, USA, 2000*.
- [3] L. Bai, L. Wang and J. Song, "Effects of Paddle Configurations on the Uniformity of the Reverberation Chamber" in *Proceedings of 1999 IEEE International Symposium on Electromagnetic Compatibility, 1999*.
- [4] J. Page "Stirred mode reverberation chambers for EMC emission measurements and radio type approvals or organised chaos" in *Ninth International Conference on Electromagnetic*

*Compatibility, 1994. (Conf. Publ. No. 396),* September 1994.

[5] J. G. Kostas and B. Boverie, "Statistical Model for a Mode-Stirred Chamber" in *IEEE Transactions on electromagnetic compatibility*, vol.33, No. 4, November 1991.

[6] G. E. P. Box, W. G. Hunter and J. S. Hunter, "Statistics for experimenters" John Wiley & Sons, 1978.

[7] D. C. Montgomery, "Design and analysis of experiments", John Wiley & Sons, 1991.